

Precision Switchmode Pulse Width Modulation Control Circuit

The TL594 is a fixed frequency, pulse width modulation control circuit designed primarily for Switchmode power supply control.

- Complete Pulse Width Modulation Control Circuitry
- On-Chip Oscillator with Master or Slave Operation
- On-Chip Error Amplifiers
- On-Chip 5.0 V Reference, 1.5% Accuracy
- Adjustable Deadtime Control
- Uncommitted Output Transistors Rated to 500 mA Source or Sink
- Output Control for Push-Pull or Single-Ended Operation
- Undervoltage Lockout

MAXIMUM RATINGS (Full operating ambient temperature range applies, unless otherwise noted.)

Rating	Symbol	Value	Unit
Power Supply Voltage	V_{CC}	42	V
Collector Output Voltage	V_{C1}, V_{C2}	42	V
Collector Output Current (each transistor) (Note 1)	I_{C1}, I_{C2}	500	mA
Amplifier Input Voltage Range	V_{IR}	-0.3 to +42	V
Power Dissipation @ $T_A \leq 45^\circ\text{C}$	P_D	1000	mW
Thermal Resistance, Junction-to-Ambient	$R_{\theta JA}$	80	$^\circ\text{C}/\text{W}$
Operating Junction Temperature	T_J	125	$^\circ\text{C}$
Storage Temperature Range	T_{stg}	-55 to +125	$^\circ\text{C}$
Operating Ambient Temperature Range TL594ID, CN TL594CD, IN	T_A	0 to +70 -25 to +85	$^\circ\text{C}$
Derating Ambient Temperature	T_A	45	$^\circ\text{C}$

NOTES: 1. Maximum thermal limits must be observed.

TL594

PRECISION SWITCHMODE PULSE WIDTH MODULATION CONTROL CIRCUIT

SEMICONDUCTOR TECHNICAL DATA

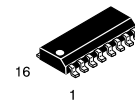

D SUFFIX
PLASTIC PACKAGE
CASE 751B
(SO-16)

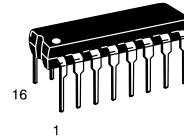

N SUFFIX
PLASTIC PACKAGE
CASE 648

PIN CONNECTIONS

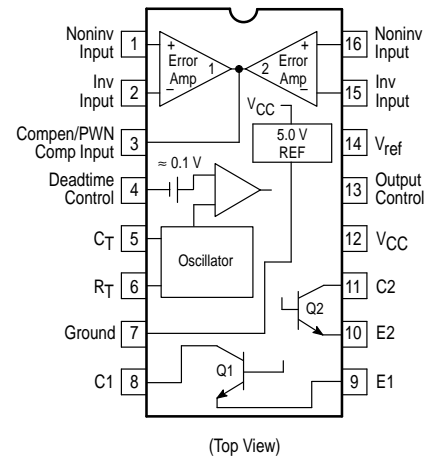

ORDERING INFORMATION

Device	Operating Temperature Range	Package
TL594CD	$T_A = 0^\circ$ to $+70^\circ\text{C}$	SO-16
TL594CN		Plastic
TL594IN	$T_A = -25^\circ$ to $+85^\circ\text{C}$	Plastic

RECOMMENDED OPERATING CONDITIONS

Characteristics	Symbol	Min	Typ	Max	Unit
Power Supply Voltage	V_{CC}	7.0	15	40	V
Collector Output Voltage	V_{C1}, V_{C2}	–	30	40	V
Collector Output Current (Each transistor)	I_{C1}, I_{C2}	–	–	200	mA
Amplified Input Voltage	V_{in}	0.3	–	$V_{CC} - 2.0$	V
Current Into Feedback Terminal	I_{fb}	–	–	0.3	mA
Reference Output Current	I_{ref}	–	–	10	mA
Timing Resistor	R_T	1.8	30	500	k Ω
Timing Capacitor	C_T	0.0047	0.001	10	μ F
Oscillator Frequency	f_{osc}	1.0	40	200	kHz
PWM Input Voltage (Pins 3, 4, 13)	–	0.3	–	5.3	V

ELECTRICAL CHARACTERISTICS ($V_{CC} = 15$ V, $C_T = 0.01$ μ F, $R_T = 12$ k Ω , unless otherwise noted.)

For typical values $T_A = 25^\circ$ C, for min/max values T_A is the operating ambient temperature range that applies, unless otherwise noted.

Characteristics	Symbol	Min	Typ	Max	Unit
-----------------	--------	-----	-----	-----	------

REFERENCE SECTION

Reference Voltage ($I_O = 1.0$ mA, $T_A = 25^\circ$ C) ($I_O = 1.0$ mA)	V_{ref}	4.925 4.9	5.0 –	5.075 5.1	V
Line Regulation ($V_{CC} = 7.0$ V to 40 V)	Reg_{line}	–	2.0	25	mV
Load Regulation ($I_O = 1.0$ mA to 10 mA)	Reg_{load}	–	2.0	15	mV
Short Circuit Output Current ($V_{ref} = 0$ V)	I_{SC}	15	40	75	mA

OUTPUT SECTION

Collector Off–State Current ($V_{CC} = 40$ V, $V_{CE} = 40$ V)	$I_{C(off)}$	–	2.0	100	μ A
Emitter Off–State Current ($V_{CC} = 40$ V, $V_C = 40$ V, $V_E = 0$ V)	$I_{E(off)}$	–	–	–100	μ A
Collector–Emitter Saturation Voltage (Note 2) Common–Emitter ($V_E = 0$ V, $I_C = 200$ mA) Emitter–Follower ($V_C = 15$ V, $I_E = -200$ mA)	$V_{SAT(C)}$ $V_{SAT(E)}$	– –	1.1 1.5	1.3 2.5	V
Output Control Pin Current Low State ($V_{OC} \leq 0.4$ V) High State ($V_{OC} = V_{ref}$)	I_{OCL} I_{OCH}	– –	0.1 2.0	– 20	μ A
Output Voltage Rise Time Common–Emitter (See Figure 13) Emitter–Follower (See Figure 14)	t_r	– –	100 100	200 200	ns
Output Voltage Fall Time Common–Emitter (See Figure 13) Emitter–Follower (See Figure 14)	t_f	– –	40 40	100 100	ns

ERROR AMPLIFIER SECTION

Input Offset Voltage (V_O (Pin 3) = 2.5 V)	V_{IO}	–	2.0	10	mV
Input Offset Current (V_O (Pin 3) = 2.5 V)	I_{IO}	–	5.0	250	nA
Input Bias Current (V_O (Pin 3) = 2.5 V)	I_{IB}	–	–0.1	–1.0	μ A
Input Common Mode Voltage Range ($V_{CC} = 40$ V, $T_A = 25^\circ$ C)	V_{ICR}	0 to $V_{CC} - 2.0$			V
Inverting Input Voltage Range	$V_{IR(INV)}$	–0.3 to $V_{CC} - 2.0$			V
Open Loop Voltage Gain ($\Delta V_O = 3.0$ V, $V_O = 0.5$ V to 3.5 V, $R_L = 2.0$ k Ω)	A_{VOL}	70	95	–	dB
Unity–Gain Crossover Frequency ($V_O = 0.5$ V to 3.5 V, $R_L = 2.0$ k Ω)	f_C	–	700	–	kHz
Phase Margin at Unity–Gain ($V_O = 0.5$ V to 3.5 V, $R_L = 2.0$ k Ω)	ϕ_m	–	65	–	deg.
Common Mode Rejection Ratio ($V_{CC} = 40$ V)	CMRR	65	90	–	dB
Power Supply Rejection Ratio ($\Delta V_{CC} = 33$ V, $V_O = 2.5$ V, $R_L = 2.0$ k Ω)	PSRR	–	100	–	dB
Output Sink Current (V_O (Pin 3) = 0.7 V)	I_{O-}	0.3	0.7	–	mA
Output Source Current (V_O (Pin 3) = 3.5 V)	I_{O+}	–2.0	–4.0	–	mA

NOTE: 2. Low duty cycle pulse techniques are used during test to maintain junction temperature as close to ambient temperature as possible.

TL594

ELECTRICAL CHARACTERISTICS ($V_{CC} = 15\text{ V}$, $C_T = 0.01\ \mu\text{F}$, $R_T = 12\ \text{k}\Omega$, unless otherwise noted.)

For typical values $T_A = 25^\circ\text{C}$, for min/max values T_A is the operating ambient temperature range that applies, unless otherwise noted.

Characteristics	Symbol	Min	Typ	Max	Unit
-----------------	--------	-----	-----	-----	------

PWM COMPARATOR SECTION (Test Circuit Figure 11)

Input Threshold Voltage (Zero Duty Cycle)	V_{TH}	–	3.6	4.5	V
Input Sink Current ($V_{Pin\ 3} = 0.7\text{ V}$)	I_{I-}	0.3	0.7	–	mA

DEADTIME CONTROL SECTION (Test Circuit Figure 11)

Input Bias Current (Pin 4) ($V_{Pin\ 4} = 0\text{ V to } 5.25\text{ V}$)	$I_{IB}\ (DT)$	–	–2.0	–10	μA
Maximum Duty Cycle, Each Output, Push–Pull Mode ($V_{Pin\ 4} = 0\text{ V}$, $C_T = 0.01\ \mu\text{F}$, $R_T = 12\ \text{k}\Omega$) ($V_{Pin\ 4} = 0\text{ V}$, $C_T = 0.001\ \mu\text{F}$, $R_T = 30\ \text{k}\Omega$)	DC_{max}	45 –	48 45	50 –	%
Input Threshold Voltage (Pin 4) (Zero Duty Cycle) (Maximum Duty Cycle)	V_{TH}	– 0	2.8 –	3.3 –	V

OSCILLATOR SECTION

Frequency ($C_T = 0.001\ \mu\text{F}$, $R_T = 30\ \text{k}\Omega$) ($C_T = 0.01\ \mu\text{F}$, $R_T = 12\ \text{k}\Omega$, $T_A = 25^\circ\text{C}$) ($C_T = 0.01\ \mu\text{F}$, $R_T = 12\ \text{k}\Omega$, $T_A = T_{low}\text{ to } T_{high}$)	f_{osc}	– 9.2 9.0	40 10 –	– 10.8 12	kHz
Standard Deviation of Frequency* ($C_T = 0.001\ \mu\text{F}$, $R_T = 30\ \text{k}\Omega$)	$\sigma_{f_{osc}}$	–	1.5	–	%
Frequency Change with Voltage ($V_{CC} = 7.0\text{ V to } 40\text{ V}$, $T_A = 25^\circ\text{C}$)	$\Delta f_{osc}\ (\Delta V)$	–	0.2	1.0	%
Frequency Change with Temperature ($\Delta T_A = T_{low}\text{ to } T_{high}$, $C_T = 0.01\ \mu\text{F}$, $R_T = 12\ \text{k}\Omega$)	$\Delta f_{osc}\ (\Delta T)$	–	4.0	–	%

UNDERVOLTAGE LOCKOUT SECTION

Turn–On Threshold (V_{CC} Increasing, $I_{ref} = 1.0\ \text{mA}$) $T_A = 25^\circ\text{C}$ $T_A = T_{low}\text{ to } T_{high}$	V_{th}	4.0 3.5	5.2 –	6.0 6.5	V
Hysteresis TL594C,I TL594M	V_H	100 50	150 150	300 300	mV

TOTAL DEVICE

Standby Supply Current (Pin 6 at V_{ref} , All other inputs and outputs open) ($V_{CC} = 15\text{ V}$) ($V_{CC} = 40\text{ V}$)	I_{CC}	– –	8.0 8.0	15 18	mA
Average Supply Current ($V_{Pin\ 4} = 2.0\text{ V}$, $C_T = 0.01\ \mu\text{F}$, $R_T = 12\ \text{k}\Omega$, $V_{CC} = 15\text{ V}$, See Figure 11)		–	11	–	mA

* Standard deviation is a measure of the statistical distribution about the mean as derived from the formula, σ

$$\sigma = \sqrt{\frac{\sum_{n=1}^N (X_n - \bar{X})^2}{N - 1}}$$

TL594

Figure 1. Representative Block Diagram

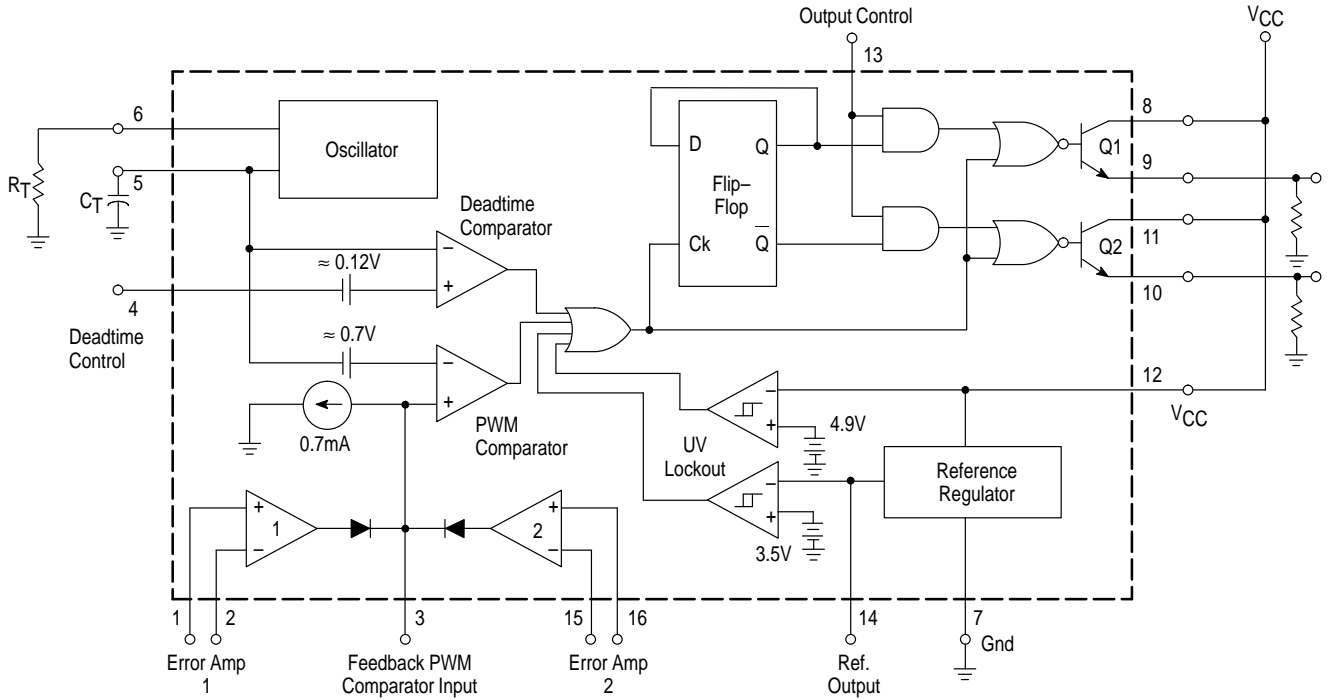

This device contains 46 active transistors.

Figure 2. Timing Diagram

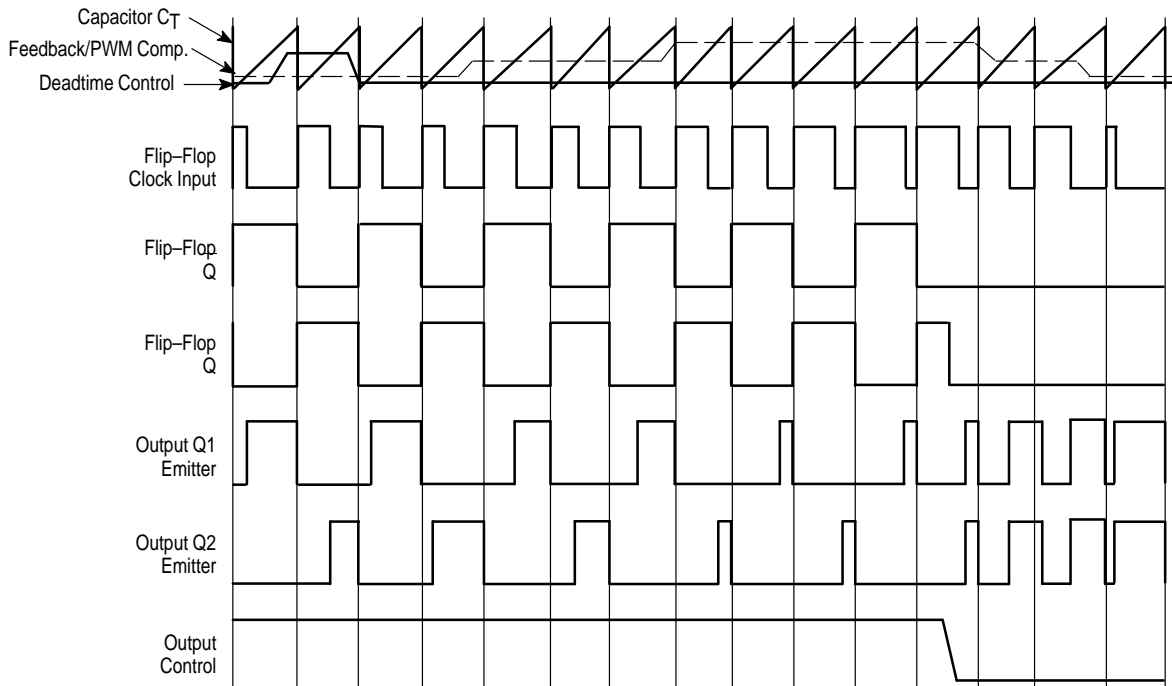

Description

The TL594 is a fixed-frequency pulse width modulation control circuit, incorporating the primary building blocks required for the control of a switching power supply. (See Figure 1.) An internal-linear sawtooth oscillator is frequency-programmable by two external components, R_T and C_T . The approximate oscillator frequency is determined by:

$$f_{osc} \approx \frac{1.1}{R_T \cdot C_T}$$

For more information refer to Figure 3.

Output pulse width modulation is accomplished by comparison of the positive sawtooth waveform across capacitor C_T to either of two control signals. The NOR gates, which drive output transistors Q1 and Q2, are enabled only when the flip-flop clock-input line is in its low state. This happens only during that portion of time when the sawtooth voltage is greater than the control signals. Therefore, an increase in control-signal amplitude causes a corresponding linear decrease of output pulse width. (Refer to the Timing Diagram shown in Figure 2.)

The control signals are external inputs that can be fed into the deadtime control, the error amplifier inputs, or the feedback input. The deadtime control comparator has an effective 120 mV input offset which limits the minimum output deadtime to approximately the first 4% of the sawtooth-cycle time. This would result in a maximum duty cycle on a given output of 96% with the output control grounded, and 48% with it connected to the reference line. Additional deadtime may be imposed on the output by setting the deadtime-control input to a fixed voltage, ranging between 0 V to 3.3 V.

The pulse width modulator comparator provides a means for the error amplifiers to adjust the output pulse width from the maximum percent on-time, established by the deadtime control input, down to zero, as the voltage at the feedback pin varies from 0.5 V to 3.5 V. Both error amplifiers have a

Functional Table

Input/Output Controls	Output Function	$\frac{f_{out}}{f_{osc}} =$
Grounded	Single-ended PWM @ Q1 and Q2	1.0
@ V_{ref}	Push-pull Operation	0.5

common-mode input range from -0.3 V to $(V_{CC} - 2 V)$, and may be used to sense power-supply output voltage and current. The error-amplifier outputs are active high and are ORed together at the noninverting input of the pulse-width modulator comparator. With this configuration, the amplifier that demands minimum output on time, dominates control of the loop.

When capacitor C_T is discharged, a positive pulse is generated on the output of the deadtime comparator, which clocks the pulse-steering flip-flop and inhibits the output transistors, Q1 and Q2. With the output-control connected to the reference line, the pulse-steering flip-flop directs the modulated pulses to each of the two output transistors alternately for push-pull operation. The output frequency is equal to half that of the oscillator. Output drive can also be taken from Q1 or Q2, when single-ended operation with a maximum on-time of less than 50% is required. This is desirable when the output transformer has a ringback winding with a catch diode used for snubbing. When higher output-drive currents are required for single-ended operation, Q1 and Q2 may be connected in parallel, and the output-mode pin must be tied to ground to disable the flip-flop. The output frequency will now be equal to that of the oscillator.

The TL594 has an internal 5.0 V reference capable of sourcing up to 10 mA of load current for external bias circuits. The reference has an internal accuracy of $\pm 1.5\%$ with a typical thermal drift of less than 50 mV over an operating temperature range of 0° to 70°C.

Figure 3. Oscillator Frequency versus Timing Resistance

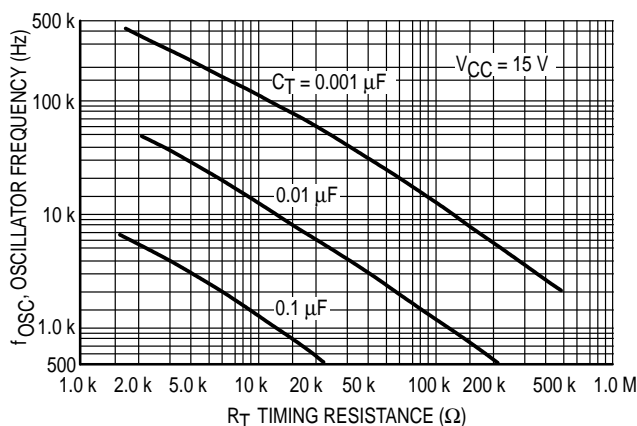

Figure 4. Open Loop Voltage Gain and Phase versus Frequency

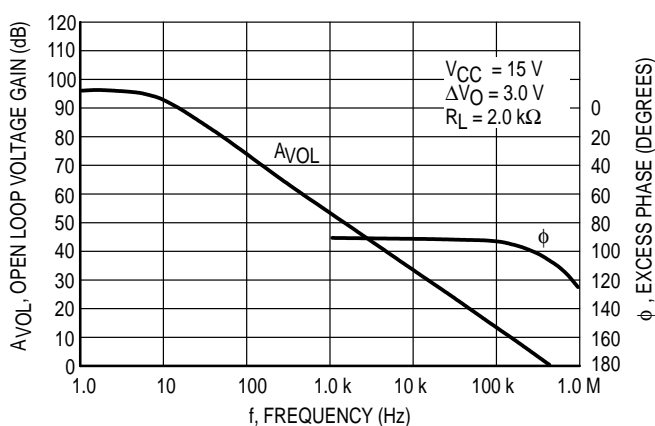

Figure 5. Percent Deadtime versus Oscillator Frequency

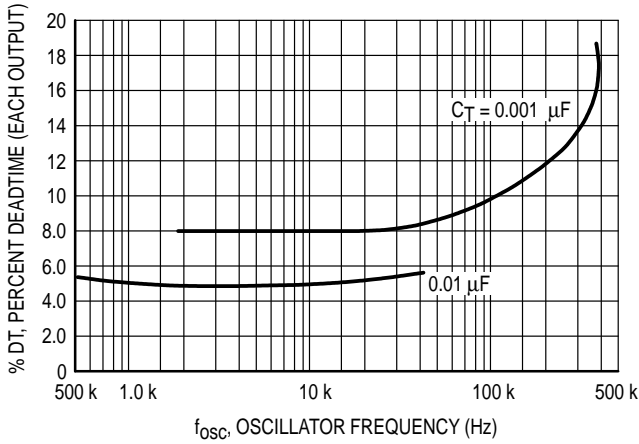

Figure 6. Percent Duty Cycle versus Deadtime Control Voltage

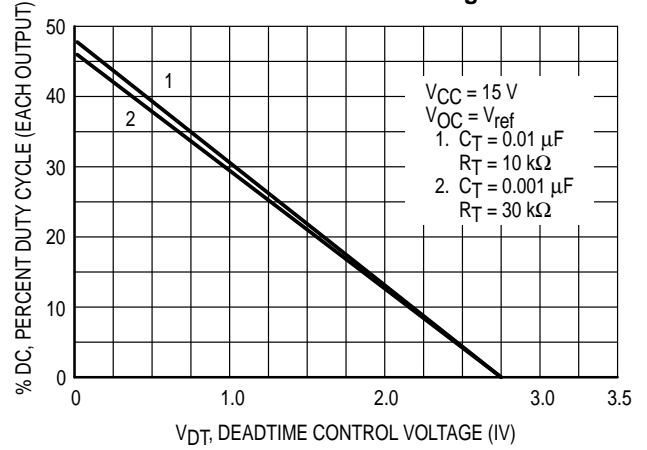

Figure 7. Emitter-Follower Configuration Output Saturation Voltage versus Emitter Current

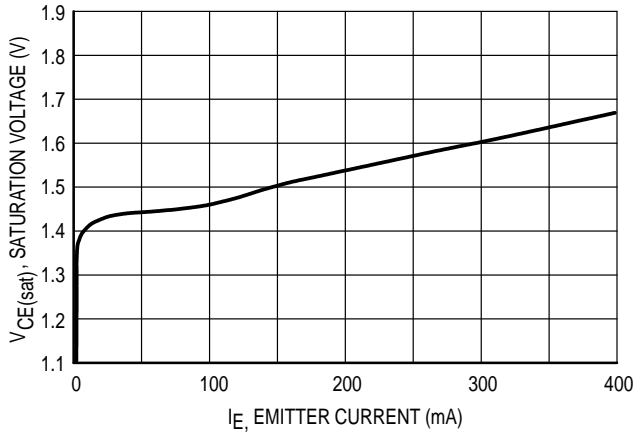

Figure 8. Common-Emitter Configuration Output Saturation Voltage versus Collector Current

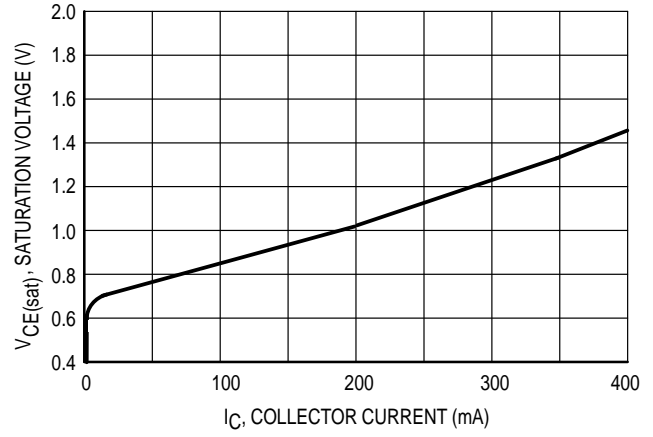

Figure 9. Standby Supply Current versus Supply Voltage

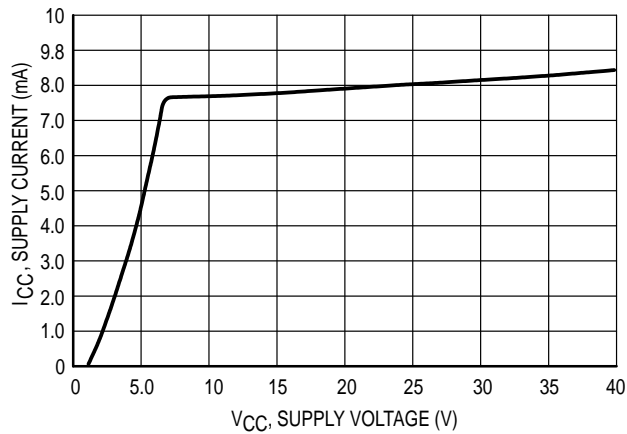

Figure 10. Undervoltage Lockout Thresholds versus Reference Load Current

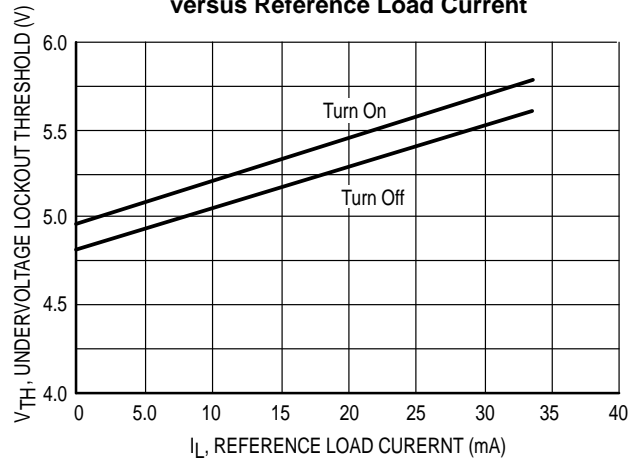

Figure 11. Error-Amplifier Characteristics

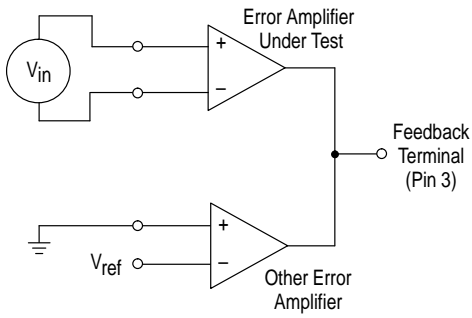

Figure 12. Deadtime and Feedback Control Circuit

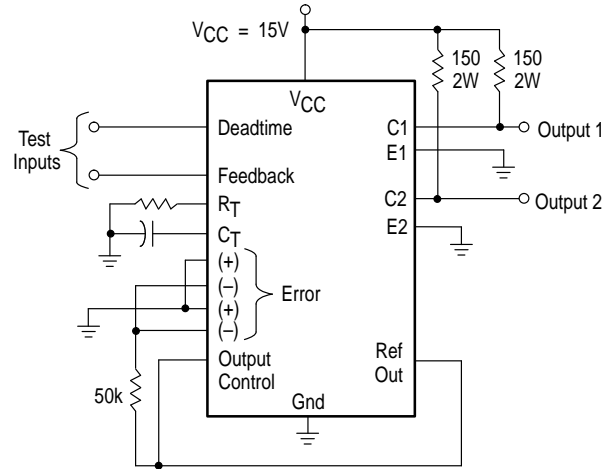

Figure 13. Common-Emitter Configuration Test Circuit and Waveform

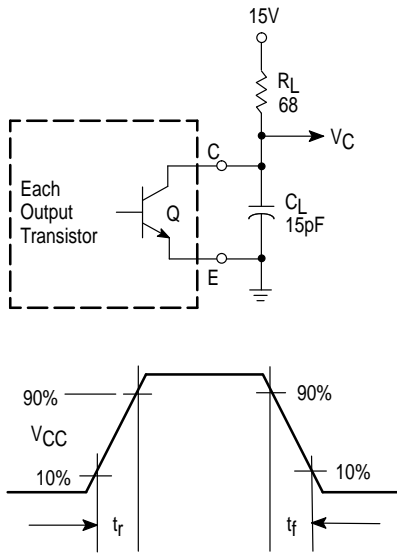

Figure 14. Emitter-Follower Configuration Test Circuit and Waveform

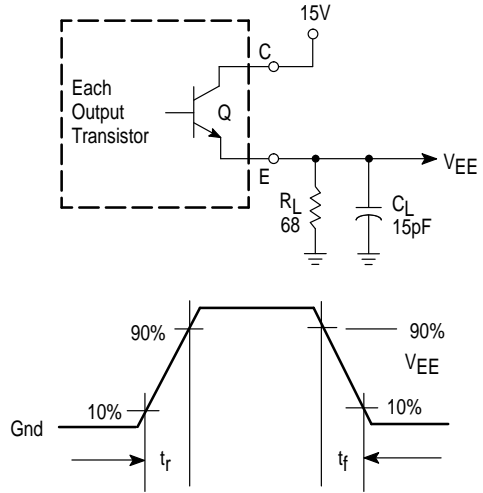

Figure 15. Error-Amplifier Sensing Techniques

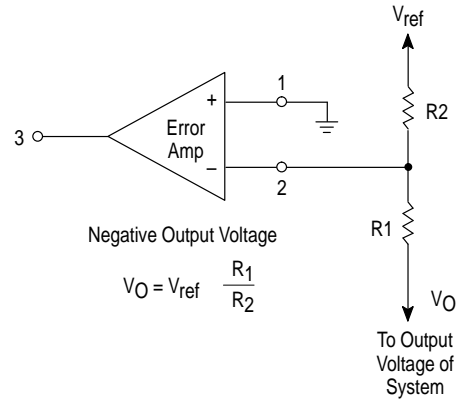
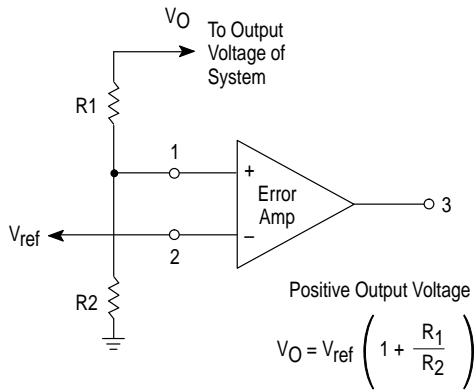
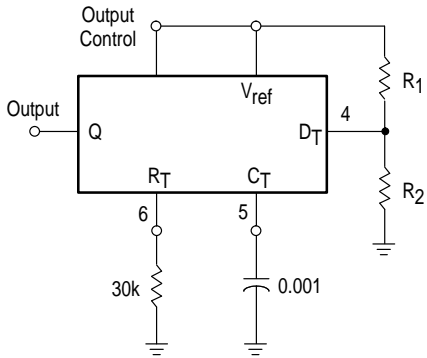

Figure 16. Deadtime Control Circuit



$$\text{Max. \% on Time, each output} \approx 45 - \left(\frac{80}{1 + \frac{R_1}{R_2}} \right)$$

Figure 17. Soft-Start Circuit

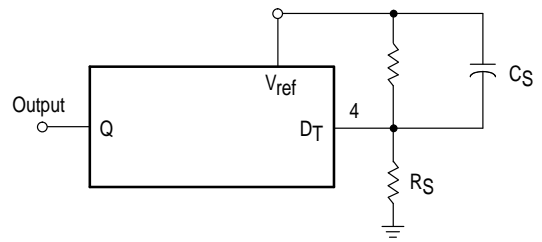
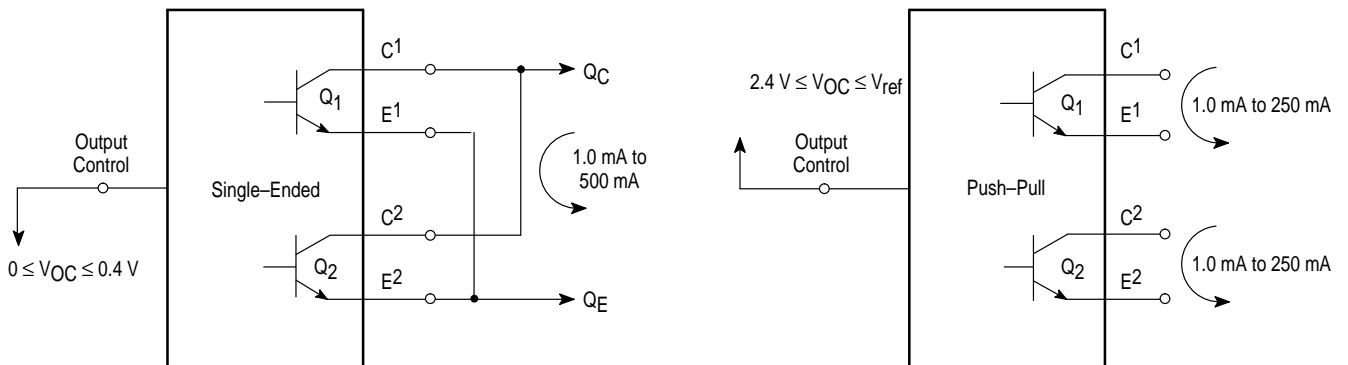

Figure 18. Output Connections for Single-Ended and Push-Pull Configurations



TL594

Figure 19. Slaving Two or More Control Circuits

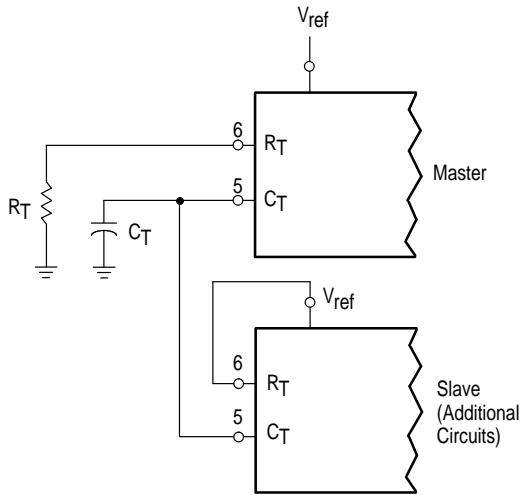

Figure 20. Operation with $V_{in} > 40\text{ V}$ Using External Zener

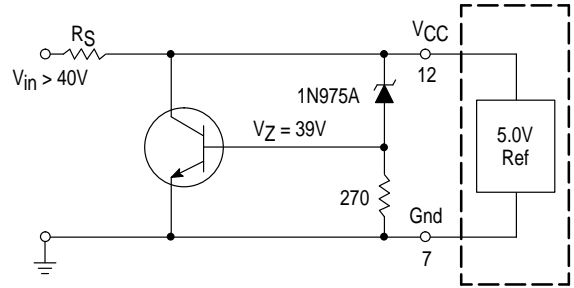
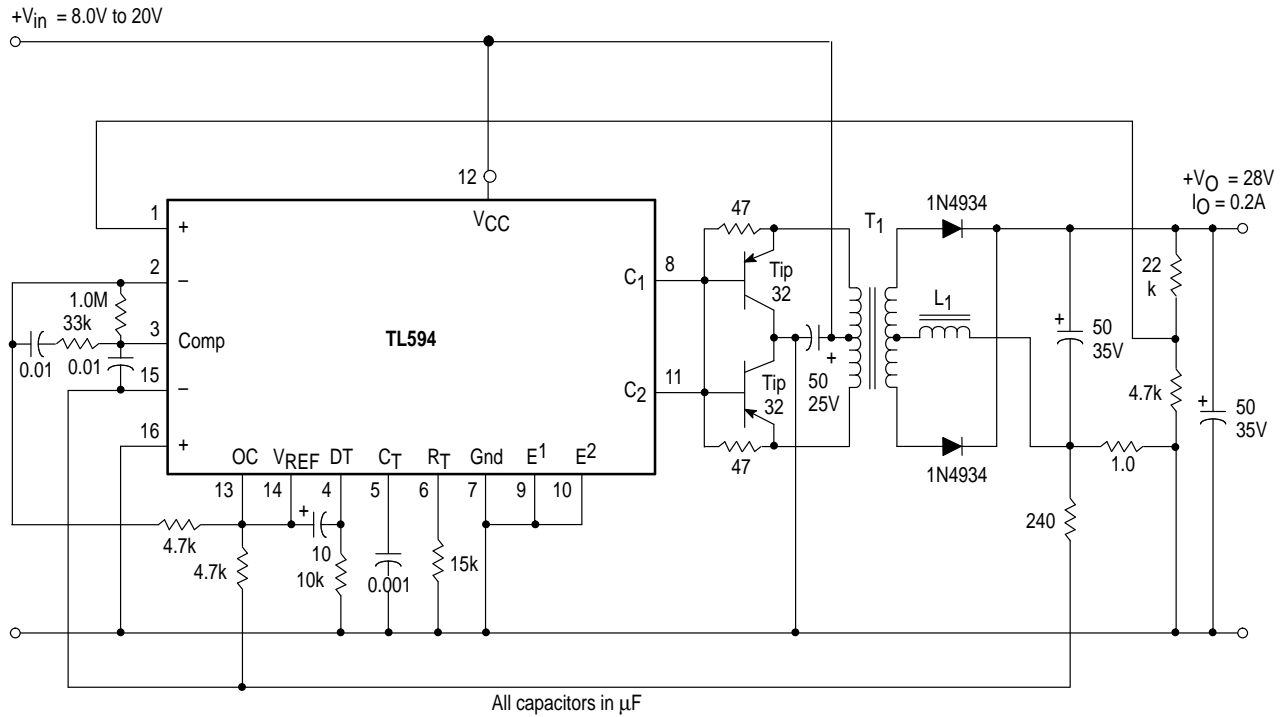

Figure 21. Pulse Width Modulated Push-Pull Converter



Test	Conditions	Results
Line Regulation	$V_{in} = 10\text{ V to }40\text{ V}$	14 mV 0.28%
Load Regulation	$V_{in} = 28\text{ V}, I_O = 1.0\text{ mA to }1.0\text{ A}$	3.0 mV 0.06%
Output Ripple	$V_{in} = 28\text{ V}, I_O = 1.0\text{ A}$	65 mVpp P.A.R.D.
Short Circuit Current	$V_{in} = 28\text{ V}, R_L = 0.1\ \Omega$	1.6 A
Efficiency	$V_{in} = 28\text{ V}, I_O = 1.0\text{ A}$	71%

L1 – 3.5 mH @ 0.3 A
T1 – Primary: 20T C.T. #28 AWG
Secondary: 120T C.T. #36 AWG
Core: Ferroxcube 1408P-L00-3CB

TL594

Figure 22. Pulse Width Modulated Step-Down Converter

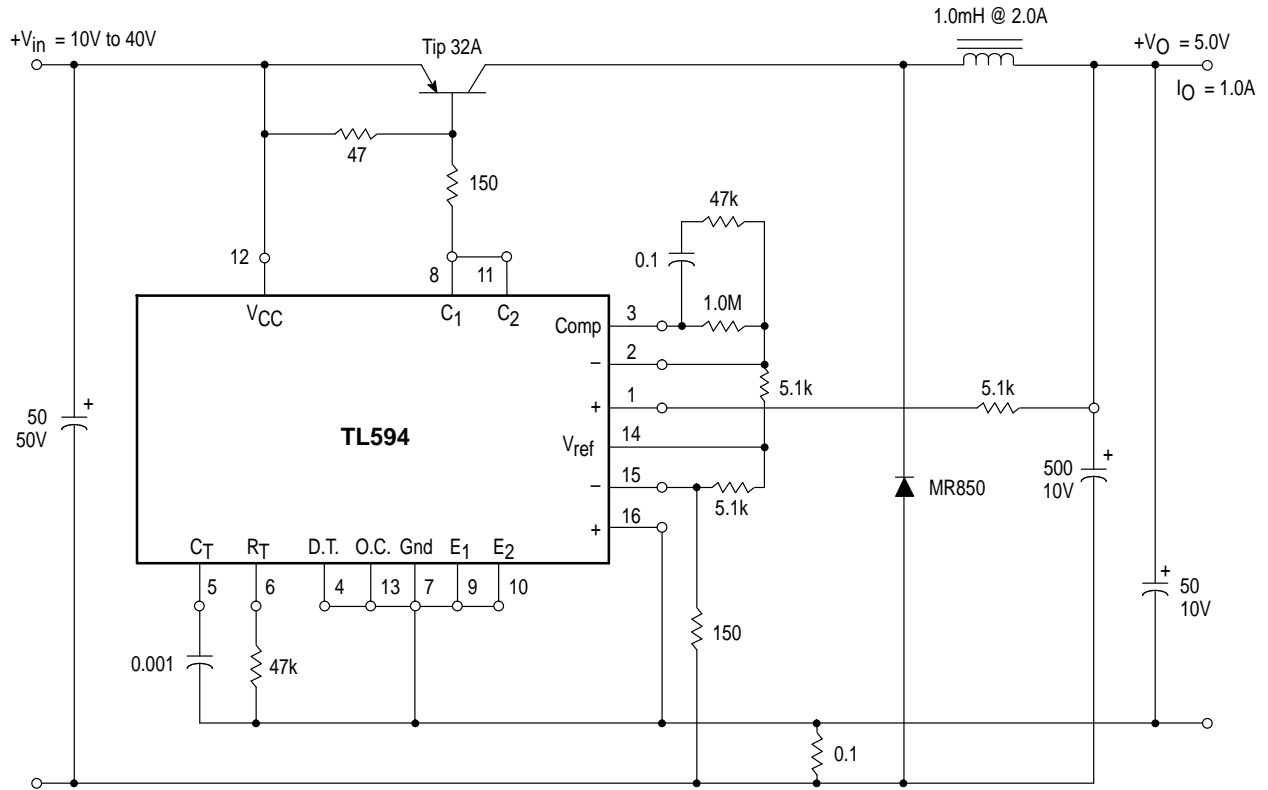

Test	Conditions	Results
Line Regulation	$V_{in} = 8.0 \text{ V to } 40 \text{ V}$	3.0 mV 0.01%
Load Regulation	$V_{in} = 12.6 \text{ V}, I_O = 0.2 \text{ mA to } 200 \text{ mA}$	5.0 mV 0.02%
Output Ripple	$V_{in} = 12.6 \text{ V}, I_O = 200 \text{ mA}$	40 mVpp P.A.R.D.
Short Circuit Current	$V_{in} = 12.6 \text{ V}, R_L = 0.1 \Omega$	250 mA
Efficiency	$V_{in} = 12.6 \text{ V}, I_O = 200 \text{ mA}$	72%

TL594

OUTLINE DIMENSIONS

D SUFFIX PLASTIC PACKAGE CASE 751B-05 (SO-16) ISSUE J

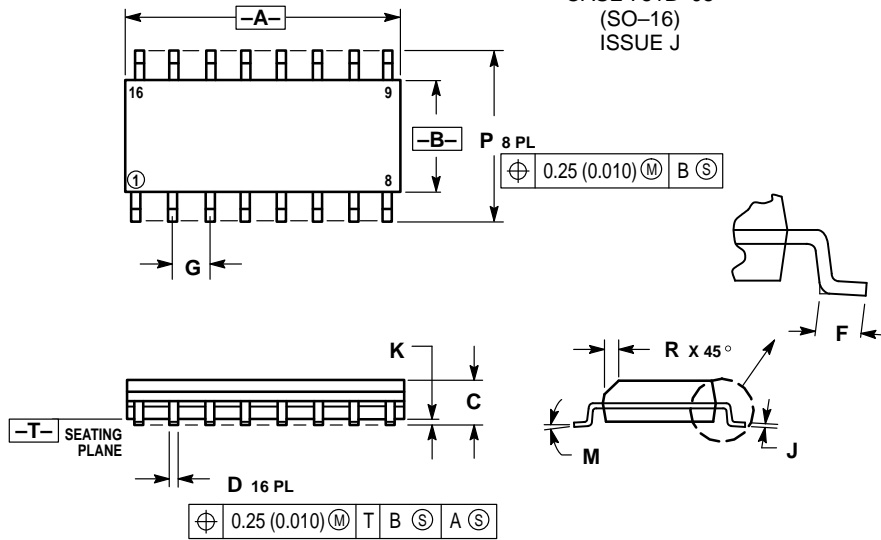

NOTES:

1. DIMENSIONING AND TOLERANCING PER ANSI Y14.5M, 1982.
2. CONTROLLING DIMENSION: MILLIMETER.
3. DIMENSIONS A AND B DO NOT INCLUDE MOLD PROTRUSION.
4. MAXIMUM MOLD PROTRUSION 0.15 (0.006) PER SIDE.
5. DIMENSION D DOES NOT INCLUDE DAMBAR PROTRUSION. ALLOWABLE DAMBAR PROTRUSION SHALL BE 0.127 (0.005) TOTAL IN EXCESS OF THE D DIMENSION AT MAXIMUM MATERIAL CONDITION.

N SUFFIX PLASTIC PACKAGE CASE 648-08 ISSUE R

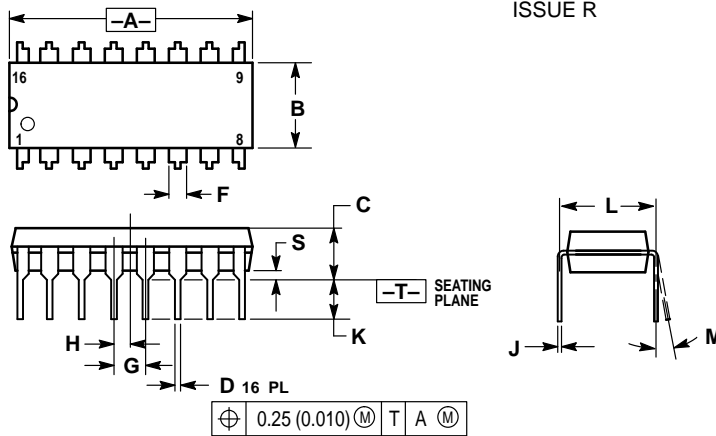

NOTES:

1. DIMENSIONING AND TOLERANCING PER ANSI Y14.5M, 1982.
2. CONTROLLING DIMENSION: INCH.
3. DIMENSION L TO CENTER OF LEADS WHEN FORMED PARALLEL.
4. DIMENSION B DOES NOT INCLUDE MOLD FLASH.
5. ROUNDED CORNERS OPTIONAL.

Motorola reserves the right to make changes without further notice to any products herein. Motorola makes no warranty, representation or guarantee regarding the suitability of its products for any particular purpose, nor does Motorola assume any liability arising out of the application or use of any product or circuit, and specifically disclaims any and all liability, including without limitation consequential or incidental damages. "Typical" parameters which may be provided in Motorola data sheets and/or specifications can and do vary in different applications and actual performance may vary over time. All operating parameters, including "Typicals" must be validated for each customer application by customer's technical experts. Motorola does not convey any license under its patent rights nor the rights of others. Motorola products are not designed, intended, or authorized for use as components in systems intended for surgical implant into the body, or other applications intended to support or sustain life, or for any other application in which the failure of the Motorola product could create a situation where personal injury or death may occur. Should Buyer purchase or use Motorola products for any such unintended or unauthorized application, Buyer shall indemnify and hold Motorola and its officers, employees, subsidiaries, affiliates, and distributors harmless against all claims, costs, damages, and expenses, and reasonable attorney fees arising out of, directly or indirectly, any claim of personal injury or death associated with such unintended or unauthorized use, even if such claim alleges that Motorola was negligent regarding the design or manufacture of the part. Motorola and  are registered trademarks of Motorola, Inc. Motorola, Inc. is an Equal Opportunity/Affirmative Action Employer.

How to reach us:

USA/EUROPE/Locations Not Listed: Motorola Literature Distribution;
P.O. Box 20912; Phoenix, Arizona 85036. 1-800-441-2447 or 602-303-5454

JAPAN: Nippon Motorola Ltd.; Tatsumi-SPD-JLDC, 6F Seibu-Butsuryu-Center,
3-14-2 Tatsumi Koto-Ku, Tokyo 135, Japan. 03-81-3521-8315

MFAX: RMFAX0@email.sps.mot.com – TOUCHTONE 602-244-6609
INTERNET: <http://Design-NET.com>

ASIA/PACIFIC: Motorola Semiconductors H.K. Ltd.; 8B Tai Ping Industrial Park,
51 Ting Kok Road, Tai Po, N.T., Hong Kong. 852-26629298



MOTOROLA

